

ANEAS 80x80

ESP

Protección tradicional de alta efectividad

Clásico sistema ideal para ser instalado en pequeñas terrazas y otras estructuras ya existentes debido a que su fijación se realiza mediante soportes que pueden instalarse sobre superficies verticales u horizontales.

Las múltiples posibilidades de instalación, unido a la fabricación de todo el producto en aluminio de la más alta calidad, convierte a Aneas en la solución ideal para todo tipo de restaurantes y negocios que buscan una personalidad propia de alto rendimiento.

ACCIONAMIENTO



Motorizado



Automatizado



Manual

POSIBILIDADES DE INSTALACIÓN



Terraza



Forjado

- ✓ **Tamaño compacto de 80x80** especialmente indicado para espacios distinguidos.
- ✓ Posibilidad de **cobertura de grandes superficies**.

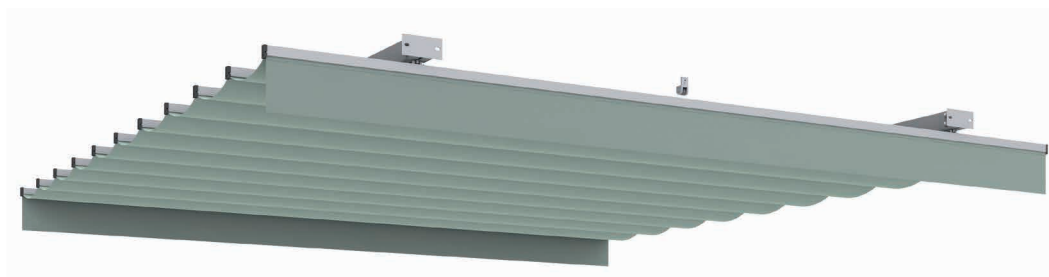

Aneas 80x80 entre paredes



Aneas 80x80 portería sin largueros



Aneas 80x80 portería con largueros

PERFILES

Medidas en mm.

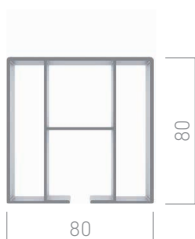

Perfil guía

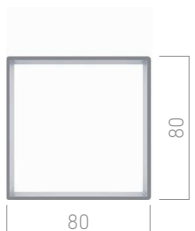

Perfil estructural

SOPORTES

Medidas en mm.



Suelo

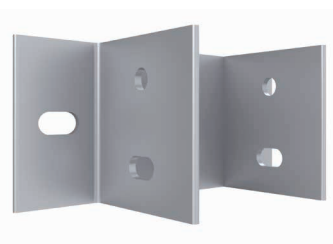

Pared

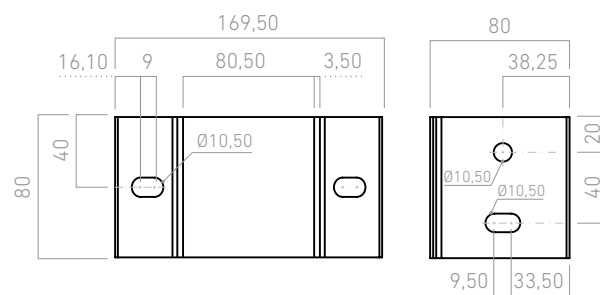
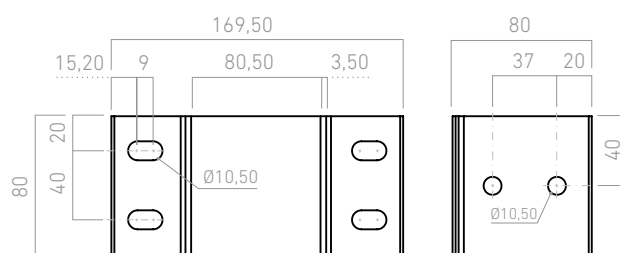

ANEAS 80x80

ENTRE PAREDES

024750

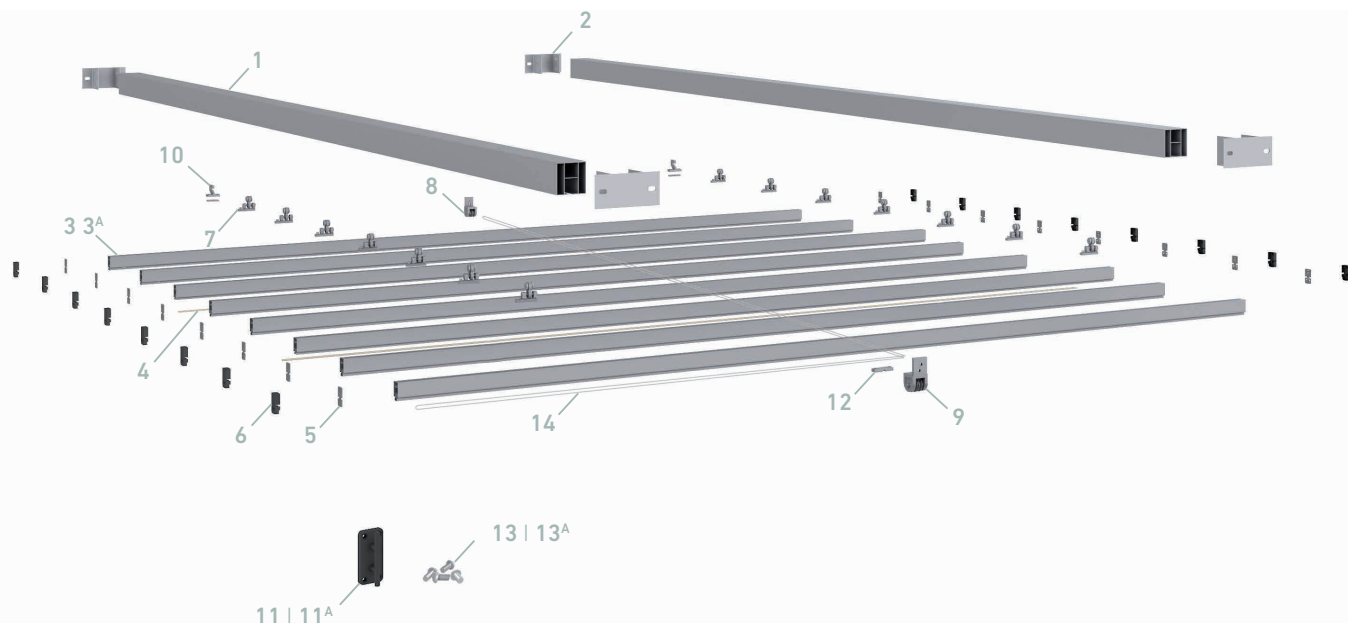

CÓDIGO	DESCRIPCIÓN
1	024647 Perfil Guía 80x80 mm
2	024679 Soporte guía 80x80 con taladros
3	024624 Perfil palillo doble Aneas
3 ^A	024623 Perfil palillo doble Aneas LED
4	024608 Difusor LED 14,3x3,5 PC Opal
5	024638 Tapa interior palillo doble Aneas
6	024669 Tapa exterior palillo doble Aneas
7	022379 Polea brida de nylon reforzada con rodamientos
8	022084 Carrucha simple

CÓDIGO	DESCRIPCIÓN
9	022593 Carrucha doble
10	022581 Conjunto gancho final
11	022129 Atacuerda plástico toldo Aneas
11 ^A	022262 Atacuerda metálico toldo Aneas
12	022111 Brida con pisacuerdas
13	024691 Kit de tornillos para soporte Aneas 80x80
13 ^A	024692 Kit de tornillos para soporte motor Aneas 80x80
14	022128 Rollo de cuerda para toldo

CLASIFICACIÓN AL VIENTO EN 13561:2004+A1:2008

SALIDA	2 GUÍAS												3 GUÍAS				
	LÍNEA																
	2,00	2,25	2,50	2,75	3,00	3,25	3,50	3,75	4,00	4,25	4,50	4,75	5,00	5,50	6,00	6,50	7,00
2,00	3	3	3	3	3	3	3	3	3	3	3	3	3	2	2	2	2
2,50	3	3	3	3	3	3	3	3	3	3	3	3	3	2	2	2	2
3,00	3	3	3	3	3	3	3	3	3	3	3	3	3	2	2	2	2
3,50	3	3	3	3	3	3	3	3	3	3	3	3	3	2	2	2	2
4,00	3	3	3	3	3	3	3	3	3	3	3	3	3	2	2	2	2
4,50	3	3	3	3	3	3	3	3	3	3	3	3	3	2	2	2	2
5,00	3	3	3	3	3	3	3	3	3	3	3	3	3	2	2	2	2
5,50	2	2	2	2	2	2	2	2	2	2	2	2	2	1	1	1	1
6,00	2	2	2	2	2	2	2	2	2	2	2	2	2	1	1	1	1
6,50	2	2	2	2	2	2	2	2	2	2	2	2	2	1	1	1	1
7,00	2	2	2	2	2	2	2	2	2	2	2	2	2	1	1	1	1

Clase 1	≈ 29 Km/h	Clase 2	≈ 38 Km/h	Clase 3	≈ 48 Km/h
---------	-----------	---------	-----------	---------	-----------

ANEAS 80x80

PORTERÍA SIN LARGUEROS

024751

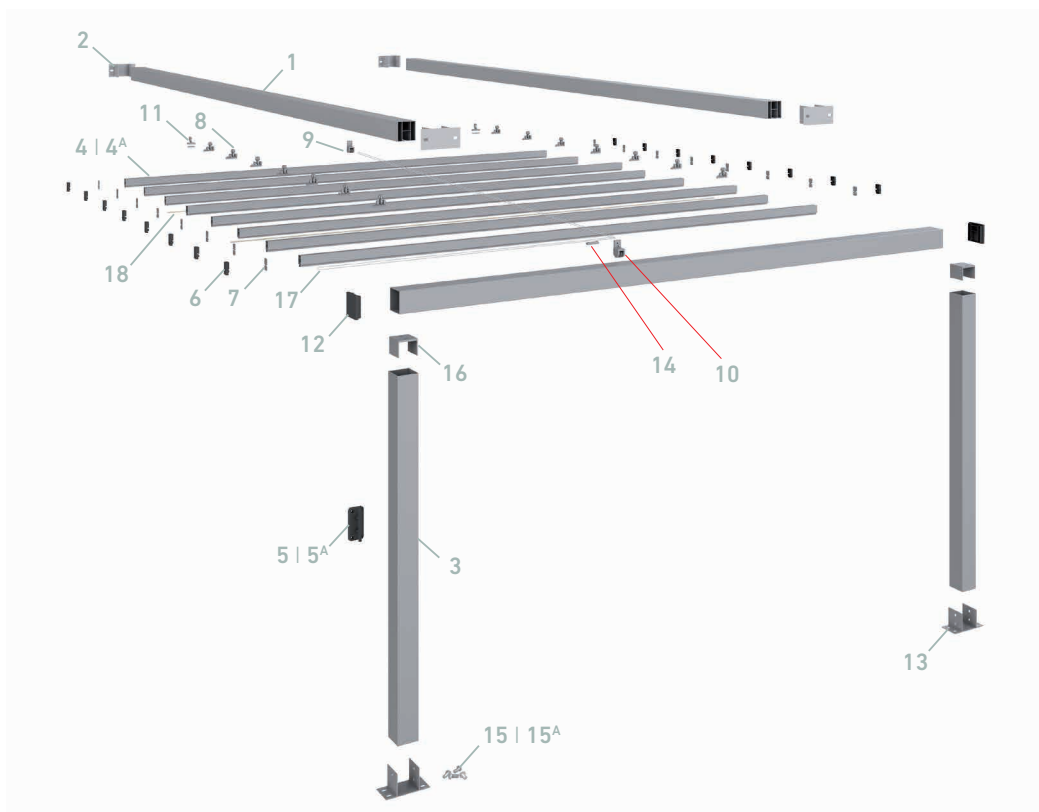

CÓDIGO	DESCRIPCIÓN	CÓDIGO	DESCRIPCIÓN
1	024647 Perfil Guía 80x80 mm	10	022593 Carrucha doble
2	024679 Soporte guía 80x80 con taladros	11	022581 Conjunto gancho final
3	024646 Tubo 80x80x2 mm	12	024685 Tapón tubo 80X80
4	024624 Perfil palillo doble Aneas	13	024682 Soporte pie 80x80 con taladros
4 ^A	024623 Perfil palillo doble Aneas LED	14	022111 Brida con pisacuerdas
5	022129 Atacuerda plástico toldo Aneas	15	024691 Kit de tornillos para soporte Aneas 80x80
5 ^A	022262 Atacuerda metálico toldo Aneas	15 ^A	024692 Kit de tornillos para soporte motor Aneas 80x80
6	024669 Tapa exterior palillo doble Aneas	16	024681 Soporte interior empalme 80x80
7	024638 Tapa interior palillo doble Aneas	17	022128 Rollo de cuerda para toldo
8	022379 Polea brida de nylon reforzado con rodamientos	18	024608 Difusor LED 14,3x3,5 PC Opal
9	022084 Carrucha simple		

CLASIFICACIÓN AL VIENTO EN 13561:2004+A1:2008

SALIDA	2 GUÍAS										3 GUÍAS						
	LÍNEA (m)																
	2,00	2,25	2,50	2,75	3,00	3,25	3,50	3,75	4,00	4,25	4,50	4,75	5,00	5,50	6,00	6,50	7,00
2,00	3	3	3	3	3	3	3	3	3	3	3	3	3	2	2	2	2
2,50	3	3	3	3	3	3	3	3	3	3	3	3	3	2	2	2	2
3,00	3	3	3	3	3	3	3	3	3	3	3	3	3	2	2	2	2
3,50	3	3	3	3	3	3	3	3	3	3	3	3	3	2	2	2	2
4,00	3	3	3	3	3	3	3	3	3	3	3	3	3	2	2	2	2
4,50	3	3	3	3	3	3	3	3	3	3	3	3	3	2	2	2	2
5,00	3	3	3	3	3	3	3	3	3	3	3	3	3	2	2	2	2
5,50	2	2	2	2	2	2	2	2	2	2	2	2	2	1	1	1	1
6,00	2	2	2	2	2	2	2	2	2	2	2	2	2	1	1	1	1
6,50	2	2	2	2	2	2	2	2	2	2	2	2	2	1	1	1	1
7,00	2	2	2	2	2	2	2	2	2	2	2	2	2	1	1	1	1

Clase 1	≈ 29 Km/h	Clase 2	≈ 38 Km/h	Clase 3	≈ 48 Km/h
---------	-----------	---------	-----------	---------	-----------

ANEAS 80x80

PORTERÍA CON LARGUEROS

024752

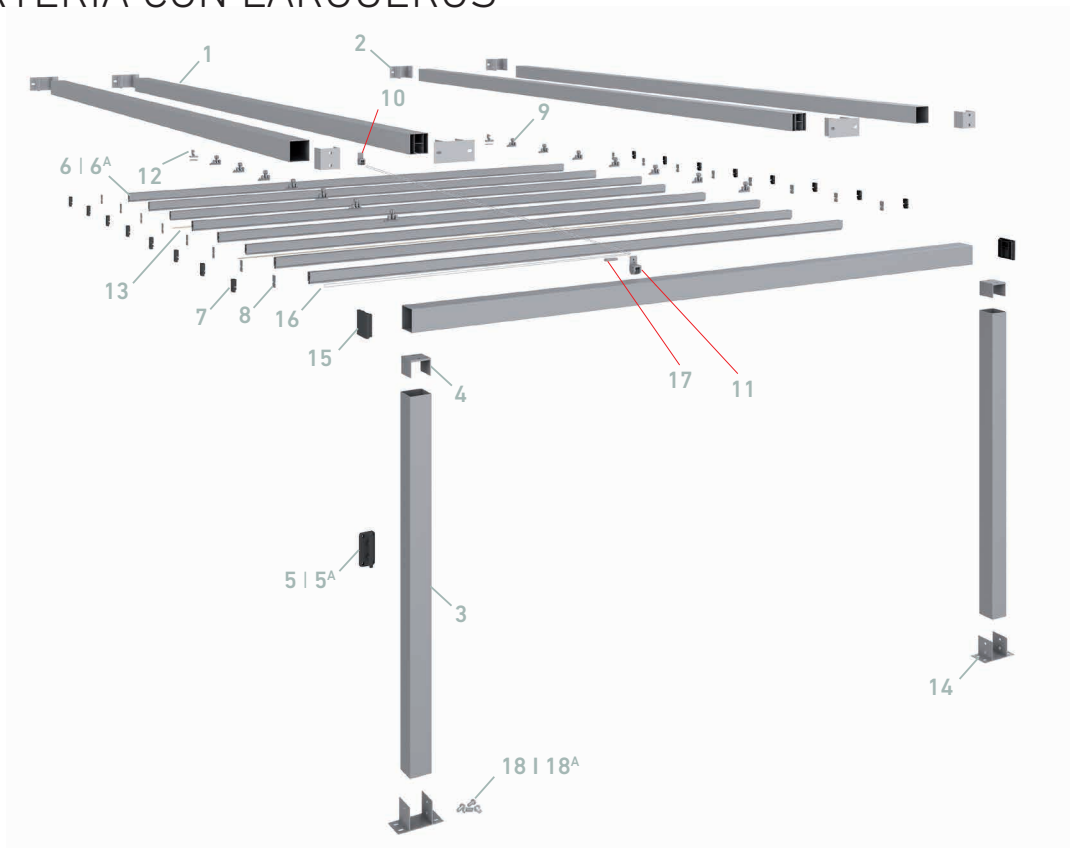

CÓDIGO	DESCRIPCIÓN
1	024647 Perfil Guía 80x80 mm
2	024679 Soporte guía 80x80 con taladros
3	024646 Tubo 80x80x2 mm
4	024681 Soporte interior empalme 80x80
5	022129 Atacuerda plástico toldo Aneas
5 ^A	022262 Atacuerda metálico toldo Aneas
6	024624 Perfil palillo doble Aneas
6 ^A	024623 Perfil palillo doble Aneas LED
7	024669 Tapa exterior palillo doble Aneas
8	024638 Tapa interior palillo doble Aneas
9	022379 Polea brida de nylon reforzado con rodamientos

CÓDIGO	DESCRIPCIÓN
10	022084 Carrucha simple
11	022593 Carrucha doble
12	022581 Conjunto gancho final
13	024608 Difusor LED 14,3x3,5 PC Opal
14	024682 Soporte pie 80x80 con taladros
15	024685 Tapón tubo 80x80
16	022128 Rollo de cuerda para toldo
17	022111 Brida con pisacuerdas
18	024691 Kit de tornillos para soporte Aneas 80x80
18 ^A	024692 Kit de tornillos para soporte motor Aneas 80x80

CLASIFICACIÓN AL VIENTO EN 13561:2004+A1:2008

SALIDA	2 GUÍAS										3 GUÍAS						
	LÍNEA																
	2,00	2,25	2,50	2,75	3,00	3,25	3,50	3,75	4,00	4,25	4,50	4,75	5,00	5,50	6,00	6,50	7,00
2,00	3	3	3	3	3	3	3	3	3	3	3	3	3	2	2	2	2
2,50	3	3	3	3	3	3	3	3	3	3	3	3	3	2	2	2	2
3,00	3	3	3	3	3	3	3	3	3	3	3	3	3	2	2	2	2
3,50	3	3	3	3	3	3	3	3	3	3	3	3	3	2	2	2	2
4,00	3	3	3	3	3	3	3	3	3	3	3	3	3	2	2	2	2
4,50	3	3	3	3	3	3	3	3	3	3	3	3	3	2	2	2	2
5,00	3	3	3	3	3	3	3	3	3	3	3	3	3	2	2	2	2
5,50	2	2	2	2	2	2	2	2	2	2	2	2	2	1	1	1	1
6,00	2	2	2	2	2	2	2	2	2	2	2	2	2	1	1	1	1
6,50	2	2	2	2	2	2	2	2	2	2	2	2	2	1	1	1	1
7,00	2	2	2	2	2	2	2	2	2	2	2	2	2	1	1	1	1

Clase 1	≈ 29 Km/h	Clase 2	≈ 38 Km/h	Clase 3	≈ 48 Km/h
---------	-----------	---------	-----------	---------	-----------

